







PumpGuard™

Eliminates the threat of flooding due to a bad pump switch. The most innovative pump protection system ever made!



Patents Pending
U.L. Listed

A pump alone cannot protect your basement ...every pump needs a PumpGuard!

-  Features an alarm override circuit and switch that will not only sound an alarm but also override the primary pump switch running your pump during a switch failure.
-  Designed specifically for use with fully-automatic 115V sump or sewage pumps utilizing a two-cord piggyback switch system.
-  Audible alarm and light
-  Dry contacts for remote monitoring
-  Optional dialer for remote alert
-  Optional battery back-up to run entire system during a power outage
-  U.L. Listed and made in the U.S.A.

TYPICAL INSTALLATION

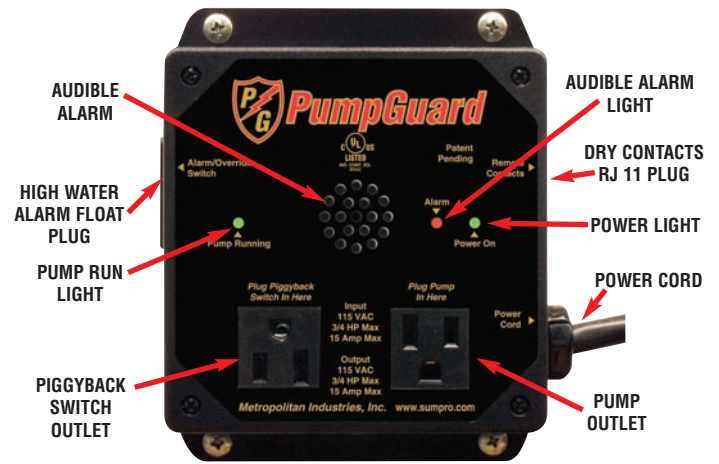
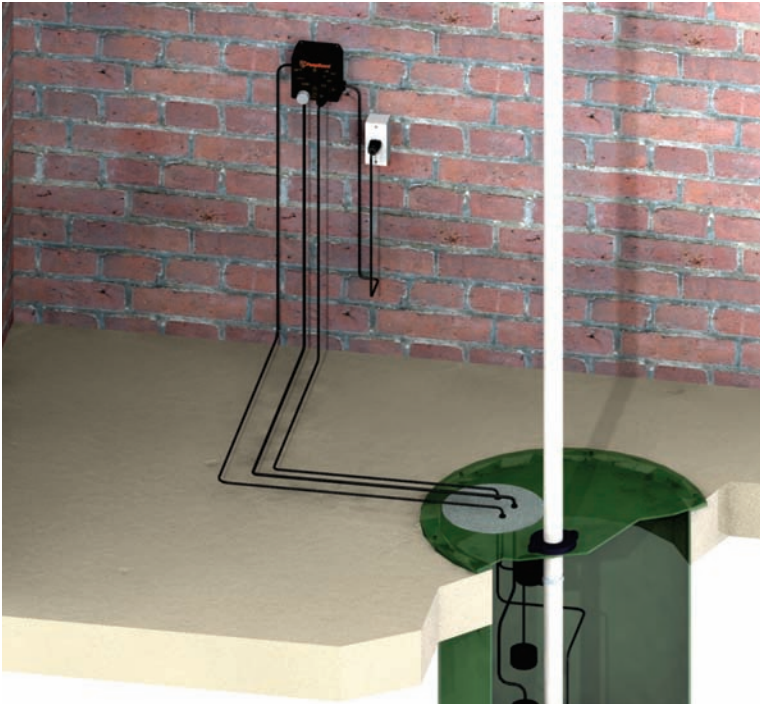

U.L. Listed

Dimensions

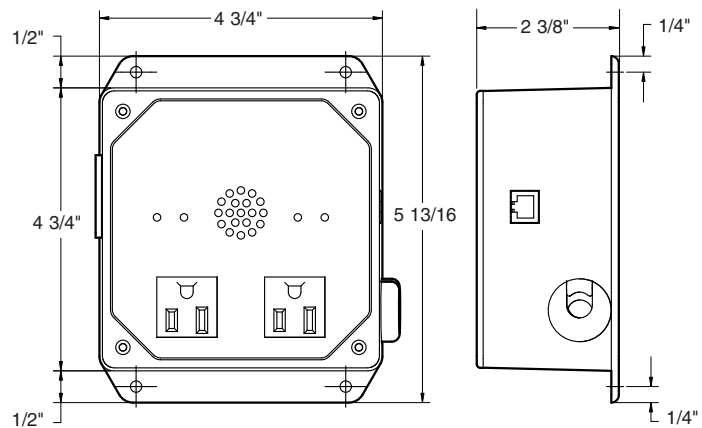

Shipping weight: 3.2 lbs.

The PumpGuard™

is the most innovative pump protection system ever made due to its ability to eliminate the threat of flooding due to a bad pump switch. The PumpGuard features an alarm override circuit and switch that will not only sound an alarm but override your primary pump switch and run your pump if the switch fails. It is designed specifically for use with fully-automatic 115V sump or sewage pumps utilizing a two-cord piggyback switch system. Combine your PumpGuard with an optional dialer for remote alert and an optional battery back up system for the ultimate in flood protection!

OPTIONS

Phone Dialer

- Connect your PumpGuard to our available phone dialer for notification of an emergency via any combination of telephones, cellular phones and pagers
- Dialer will call up to nine different numbers using your pre-programmed, 40 second emergency message
- Dialer will override an occupied line for an emergency call
- Power failure alarm alerts you to a power outage



SUMPRO

- Install the fully-automatic 115V Sumpro Battery Back-Up System that operates on either AC or DC power
- Sumpro will operate your entire pump system during a power outage keeping your basement dry
- Provides ultimate protection against blackouts and/or brownouts



Manufacturers, Distributors and Innovators of Quality Equipment



37 Forestwood Drive
Romeoville, IL 60446
Telephone: (815) 886-9200
www.sumpro.com